

# DATA SHEET

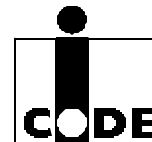

## **SL1 ICS30 01** **I•CODE1 Label IC** **Chip Specification**

Product Specification  
Revision 2.2  
Public

January 2005



---

# 1 Contents

---

<b>1</b>	<b>CONTENTS</b>	<b>2</b>
<b>2</b>	<b>DEFINITIONS</b>	<b>4</b>
2.1	Life Support Applications .....	4
2.2	Abbreviations .....	4
<b>3</b>	<b>SCOPE</b>	<b>5</b>
<b>4</b>	<b>ORDERING INFORMATION</b>	<b>5</b>
<b>5</b>	<b>FUNCTIONAL DESCRIPTION</b>	<b>6</b>
5.1	Basic Features .....	6
5.2	Block Diagram of the IC.....	6
5.3	Memory Organisation.....	7
5.3.1	Serial Number .....	7
5.3.2	Write Access Conditions .....	7
5.3.3	Special Functions (EAS/QUIET).....	8
5.3.4	Family Code and Application Identifier.....	8
5.3.5	Configuration of delivered ICs.....	9
<b>6</b>	<b>MECHANICAL DIE SPECIFICATIONS</b>	<b>10</b>
<b>7</b>	<b>MECHANICAL WAFER SPECIFICATIONS</b>	<b>11</b>
7.1	Wafer Status .....	11
7.2	Backside Treatment .....	11
<b>8</b>	<b>DOCUMENTATION</b>	<b>12</b>
8.1	Delivery Documentation.....	12
8.2	Fail-Die Identification.....	12
8.2.1	Ink Dot Specification.....	12
8.2.2	Wafer Mapping.....	12
<b>9</b>	<b>QUALITY ASSURANCE</b>	<b>13</b>
9.1	Electrical Acceptance Test.....	13
9.2	Visual Inspection.....	13
9.2.1	After Wafer Final Test .....	13
9.2.2	After Sawing (Film Frame Carrier).....	13
<b>10</b>	<b>PACKING</b>	<b>14</b>
10.1	Storage Recommendations .....	14
10.2	Delivery form .....	14
<b>11</b>	<b>HANDLING RECOMMENDATIONS</b>	<b>15</b>

---

11.1	Die Attach.....	15
11.2	Wire Bonding.....	15
12	COIL SPECIFICATION	15
13	ELECTRICAL SPECIFICATIONS	16
14	HINTS FOR LABEL IC ENCAPSULATION	17
14.1	Protection against Visible Light.....	17
14.2	Protection against UV Light.....	17
14.3	Resistance to X-Rays.....	17
15	INLET/LABEL CHARACTERISATION AND TEST	18
15.1	Characterisation of the Inlet/Label.....	18
15.2	Final Test of the Inlet/Label.....	18
16	APPENDIX A: DIE PLAN	19
17	APPENDIX B: CLUSTER PLAN	20
18	APPENDIX C: CLUSTER MAP	21
19	REVISION HISTORY	22

## 2 Definitions

<b>Data sheet status</b>	
Objective specification	This data sheet contains target or goal specifications for product development.
Preliminary specification	This data sheet contains preliminary data; supplementary data may be published later.
Product specification	This data sheet contains final product specifications.
<b>Limiting values</b>	
Limiting values given are in accordance with the Absolute Maximum Rating System (IEC 134). Stress above one or more of the limiting values may cause permanent damage to the device. These are stress ratings only and operation of the device at these or at any other conditions above those given in the Characteristics section of the specification is not implied. Exposure to limiting values for extended periods may affect device reliability.	
<b>Application information</b>	
Where application information is given, it is advisory and does not form part of the specification.	

### 2.1 Life Support Applications

These products are not designed for use in life support appliances, devices, or systems where malfunction of these products can reasonably be expected to result in personal injury. Philips customers using or selling these products for use in such applications do so on their own risk and agree to fully indemnify Philips for any damages resulting from such improper use or sale.

### 2.2 Abbreviations

ASCII	American Standard Code for Information Interchange
CSC	Cyclic Redundancy Check
EAN	European Article Number
EAS	Electronic Article Surveillance
EEPROM	Electrically Erasable and Programmable Read Only Memory
EMI	Electromagnetic Interference
ETSI	European Telecommunications Standards Institute
FCC	Federal Communications Commission
FFC	Film Frame Carrier
Hex	Value in hexadecimal notation
IC	Integrated Circuit
ISM	Industrial, Scientific, Medical
LSB	Least Significant Bit or Byte
MSB	Most Significant Bit or Byte
MTBF	Mean Time Between Failure
PCB	Printed Circuit Board
PCM	Process Control Module
RF	Radio Frequency
rms	Root Mean Square
SNR	Serial Number
UV	Ultraviolet

---

## 3 Scope

---

This specification describes the electrical, physical and dimensional properties of unsawn and sawn wafers on FFC of I•CODE1 Label ICs on a Philips 6C15 IDFW process and is the base for delivery of tested I•CODE1 Label ICs.

General recommendations are given for storage, handling and processing of wafers as well as assembly of labels.

Reference documents:

- MIL-STD 883D Method 3023
- MIL-STD 883D Method 3015
- SNW-FQ-627
- PICTOH-QS007
- General Specification for 6" Wafer (Prod. Spec.)
- General Quality Specification
- I•CODE1 Label IC, Coil Design Guide

This product specification is valid for VCOL1V0 from mask revision P/B upwards.

## 4 Ordering Information

---

Following ordering options are available:

Type Name	Description	Ordering Code
SL1 ICS30 01W/N5D	Sawn wafer on foil (FFC), 150 µm, inked and mapped	9352 644 66005

# 5 Functional Description

## 5.1 Basic Features

The I•CODE1 Label IC is a dedicated chip for intelligent label applications like logistics and retail (including EAS) as well as baggage and parcel identification in airline business and mail services.

The I•CODE system offers the possibility of operating labels simultaneously in the field of the reader antenna (*Anticollision*). It is designed for long range applications.

Whenever connected to a very simple and cheap type of antenna (as a result of the 13.56 MHz carrier frequency) made out of a few windings printed, winded, etched or punched coil the I•CODE1 Label IC can be operated without line of sight up to a distance of 1.5 m (gate width).

## 5.2 Block Diagram of the IC

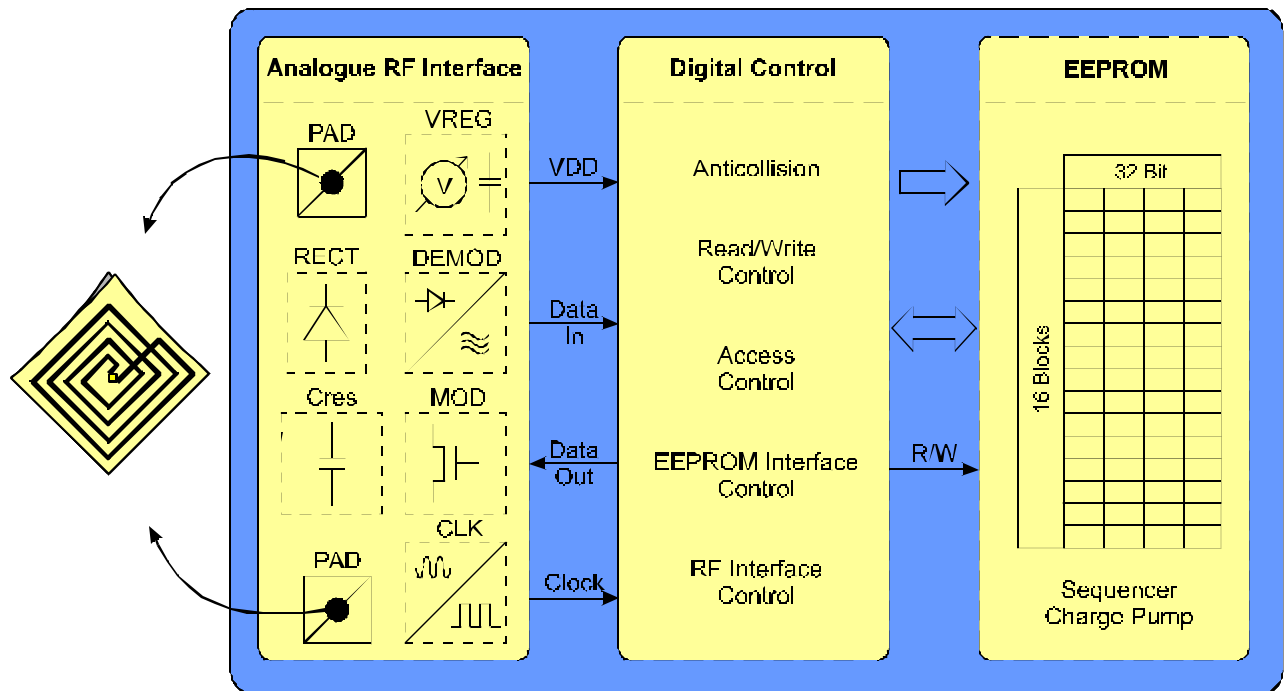

The label requires no internal power supply. Its contactless interface generates the power supply and the system clock via the resonant circuitry by inductive coupling to the reader. The interface also demodulates data that are transmitted from the reader to the I•CODE Label, and modulates the electromagnetic field for data transmission from the I•CODE Label to the reader.

Data are stored in a non-volatile memory (EEPROM). The EEPROM has a memory capacity of 512 bit and is organised in 16 blocks consisting of 4 bytes each (1 block = 32 bits). The higher 12 blocks contain user data and the lowest 4 blocks contain the serial number, the write access conditions and some configuration bits.

## 5.3 Memory Organisation

The 512 bit EEPROM memory is divided into 16 blocks. A block is the smallest access unit. Each block consists of 4 bytes (1 block = 32 bits). Bit 0 in each byte represents the least significant bit (LSB) and bit 7 the most significant bit (MSB), respectively.

	Byte 0	Byte 1	Byte 2	Byte 3	
Block 0	SNR0	SNR1	SNR2	SNR3	Serial Number (lower bytes)
Block 1	SNR4	SNR5	SNR6	SNR7	Serial Number (higher bytes)
Block 2	F0	FF	FF	FF	Write Access Conditions
Block 3	x	x	x	x	Special Functions (EAS/QUIET)
Block 4	x	x	x	x	Family Code/Application Identifier/User Data
Block 5	x	x	x	x	User Data
Block 6	x	x	x	x	:
Block 7	x	x	x	x	:
Block 8	x	x	x	x	:
Block 9	x	x	x	x	:
Block 10	x	x	x	x	:
Block 11	x	x	x	x	:
Block 12	x	x	x	x	:
Block 13	x	x	x	x	:
Block 14	x	x	x	x	:
Block 15	x	x	x	x	User Data

The values (in hexadecimal notation) shown in the table above are stored in the EEPROM after the wafer production process. The contents of blocks marked with 'x' in the table are **not** defined at delivery.

### 5.3.1 Serial Number

The unique 64 bit serial number is stored in blocks 0 and 1 and is programmed during the production process. SNR0 in the table represents the least significant byte and SNR7 the most significant byte, respectively.

### 5.3.2 Write Access Conditions

The Write Access Condition bits in block 2 determine the write access conditions for each of the 16 blocks. These bits can be set only to 0 (and never be changed to 1), i.e. already write protected blocks can never be written to from this moment on. This is also true for block 2. If this block is set into write protected state by clearing of bits 4 and 5 at byte 0, no further changes in write access conditions are possible.

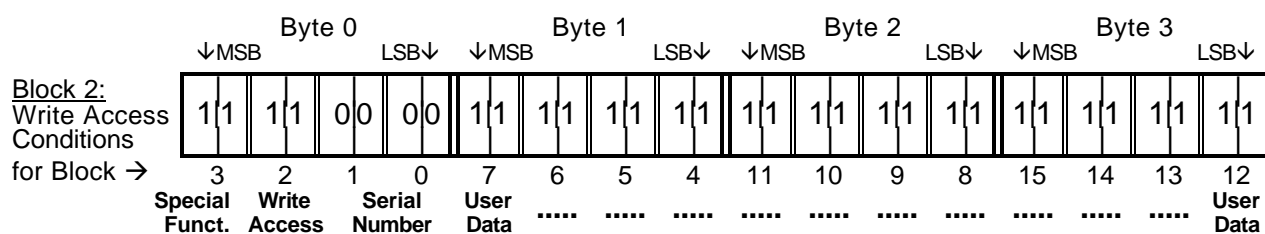

The ones in the 16 pairs of bits have to be cleared together if the corresponding block is wanted to be write protected forever (1|1 → write access enabled, 0|0 → write access disabled). Writing of bit pairs 1|0 or 0|1 to block 2 is not allowed!

**It is extremely important to be particularly careful when clearing the Write Access bits in block 2, as you can lose write access to all of the blocks on the label in case of a mistake. Of course you can use this feature to put the label into a hardware write protected state!**

### 5.3.3 Special Functions (EAS/QUIET)

The Special Functions block holds the two EAS bits (Electronic Article Surveillance mode active → the label answers at an EAS command) as well as the two QUIET bits (QUIET mode enabled → the label is permanently disabled but can be activated again with the ‘Reset QUIET bit’ command). The state of QUIET mode does **not** influence the functionality of the EAS command.

The remaining 28 bits (greyed ‘x’ in the following figure) are reserved for future use.

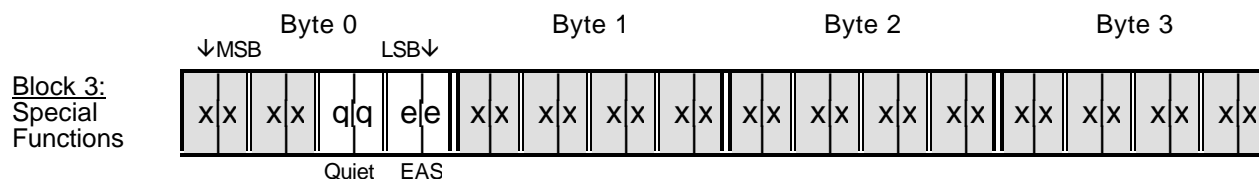

Quiet:      q|q = 1|1 → QUIET mode enabled      q|q = 0|0 → QUIET mode disabled  
 EAS:        e|e = 1|1 → EAS mode enabled        e|e = 0|0 → EAS mode disabled

Writing of bit pairs 1|0 or 0|1 to block 3 is not allowed!

**Changing of the Write Access Control or Configuration must be done in secure environment (by reading the current value of the block and masking in the new values for bit positions that may be changed). The label must not be moved out of the communication field of the antenna during writing! We recommend to put the label close to the antenna and not to remove it during operation.**

### 5.3.4 Family Code and Application Identifier

The I•CODE system offers the feature to use (independently) Family Codes and/or Application Identifiers with some reader commands (this allows for example the creation of ‘label families’).

These two 8-bit values are located at the beginning of User Data (block 4) as shown in the following figure and are only evaluated if the corresponding bytes at the reader commands are unequal to zero.

Only if both corresponding parameter bytes at the reader commands Anticollision/Select, EAS and Unselected Read, respectively, are set to zero, block 4 can be used for user data without restriction.

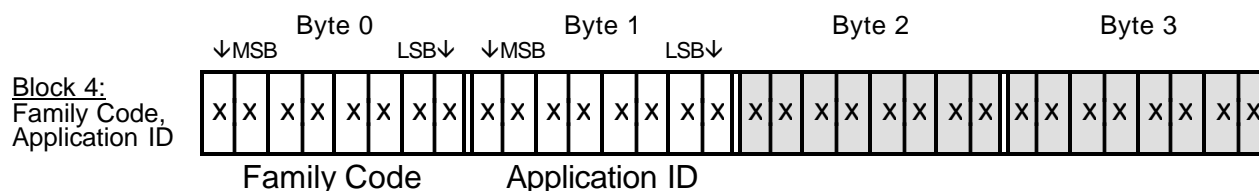

The greyed bytes are for customer usage as well as the remaining blocks (5 to 15) are.



---

### 5.3.5 Configuration of delivered ICs

I•CODE1 Label ICs are delivered with the following configuration by Philips:

- Serial number is unique and read only
- Write Access Conditions allow to change all blocks (with the exception of both serial number blocks)
- Status of EAS mode is **not** defined
- Status of QUIET mode is **not** defined
- Family Code and Application Identifier are **not** defined
- User Data memory is **not** defined

**As the status of QUIET mode is not defined at delivery, the first command to be executed on the I•CODE1 Label IC should be the Reset QUIET Bit command!**

**NOTE: Due to the fact that the EAS mode is undefined at delivery, the EAS MODE shall be set (enable or disable) according to your application requirements during the test or initialisation phase.**

---

## 6 Mechanical Die Specifications

---

Designation:	VCOL1V0 visible on each die location see attached die plan
Bond pad location:	see attached die plan
Bond pad size: LA, LB	130 $\mu\text{m}$ x 150 $\mu\text{m}$
Test pad size: TEST, VSS	90 $\mu\text{m}$ x 90 $\mu\text{m}$ (the test pads are electrically neutral at sawn wafers)
Bond pad metallisation material:	AlSiCu
Metallisation thickness:	1.4 $\mu\text{m}$
Die dimensions (incl. 80 $\mu\text{m}$ scribe line):	1460 $\mu\text{m}$ x 1490 $\mu\text{m}$
Die dimensions (excl. scribe line):	1380 $\mu\text{m}$ x 1410 $\mu\text{m}$
Tolerances for sawn dies:	$\pm 25 \mu\text{m}$
Pin identification:	see attached die plan
Passivation attributes:	
The passivation is a protection of active areas against dust (particles) and humidity and general contamination (whole surface of the chip except for the bond pads).	
Top side passivation material:	Oxynitride
Passivation thickness:	1.6 $\mu\text{m}$
Due to the glass-like physical properties careful handling and processing is required.	
Available die backside treatment:	etched

---

# 7 Mechanical Wafer Specifications

---

**For further information as described in the following chapters please refer to the following Philips documents:**

- Dicing Guidelines for Thin Wafers (< 200  $\mu\text{m}$ )
- General Specification for 6" Wafer (Prod. Spec.)

In case of doubt or inconsistency with the following chapters the above mentioned specifications are applicable.

Designation:	each wafer is laser scribed with batch and wafer number
Wafer diameter:	150 mm (6") $\pm$ 0.3 mm
Die separation lane width:	80 $\mu\text{m}$ (Scribe line)
Electrical connection of substrate:	VSS
Geometrically complete dies per wafer:	approx. 7400
Orientation of dies relat. to wafer flat:	see attached cluster map
Position of test structures:	see attached cluster map
Wafer layout:	see attached cluster map
Batch size:	24 wafers
Process:	6C15 IDFW

## 7.1 Wafer Status

- Tested, sawn on FFC

Minimum yield per lot:	30 %
------------------------	------

## 7.2 Backside Treatment

Wafers can be delivered with a thickness of  $150 \mu\text{m} \pm 15 \mu\text{m}$  (approx. 6 mil) grinded and etched backside.

---

# 8 Documentation

---

## 8.1 Delivery Documentation

Each wafer container and each larger shipment container is individually marked with the identification information as follows:

- Diffusion Batch number (wafer lot number)
- Part designation (type) with revision number
- Ordering code (see chapter 4)
- Date code of lot acceptance
- Good die quantity

The print out of the final test results is attached to the packing and contains the good die quantity related to every wafer number.

## 8.2 Fail-Die Identification

Every die is electrically tested according to data sheet. Identification of chips with electrical parameters not conform with the data sheet is done by inking and wafer mapping (all dies at wafer periphery are identified as 'FAIL').

### 8.2.1 Ink Dot Specification

Diameter:	min. 0.4 mm
Height:	max. 20 $\mu$ m
Colour:	black
Position:	central third of die (x, y direction)
Attributes:	opaque, water resistant

**NOTE: Uncompleted dies with an area < 95 % (wafer periphery) are not inked!**

### 8.2.2 Wafer Mapping

Wafer mapping for failed die identification is available on Floppy-Disk.

Format: IBIS format on 3.5" Floppy-Disk

---

## 9 Quality Assurance

---

### 9.1 Electrical Acceptance Test

The electrical acceptance test is performed in line ('sampling on the fly') according to the test specifications.

Sampling plan: according General Quality Specification

### 9.2 Visual Inspection

#### 9.2.1 After Wafer Final Test

Performed according document SNW-FQ-627.

Sampling plan: according General Quality Specification

#### 9.2.2 After Sawing (Film Frame Carrier)

Performed according document PICTOH-QS007.

Sampling plan (3 wafers per lot): accept 0/3

---

# 10 Packing

---

The packing for shipment of wafers has to protect the wafers against shock, severe impact, dust and electrostatic discharge. The packing of sawn wafers is done according to Philips 'General Specification for 6" Wafer (Prod. Spec.)'.

## 10.1 Storage Recommendations

Sawn wafers should be kept in their original packing whilst in storage.

Recommended storage conditions:

Temperature:	15 ... 25 °C
Climate atmosphere:	40 ... 60 % r.h. or dried N <sub>2</sub> (only unsawn wafers!)
Duration of storage:	max. 6 months

Deviating requirements have to be arranged between customer and Philips Semiconductors.

## 10.2 Delivery form

Delivery form:	Film Frame Carrier (standard Philips carrier type P7)
Foil thickness:	0.55 ... 0.85 mm
Foil material:	sticky foil

---

## 11 Handling Recommendations

---

Please refer to Philips 'General Specification for 6" Wafer (Prod. Spec.)' for the following items:

### 11.1 Die Attach

### 11.2 Wire Bonding

## 12 Coil Specification

---

The I•CODE1 Label IC has to be connected at pads LA, LB to a coil characterised by its electrical parameters according to Philips application note 'SL1 ICS30 01 I•CODE1 Label IC, Coil Design Guide'.

# 13 Electrical Specifications

## ABSOLUTE MAXIMUM RATINGS<sup>1, 2</sup>

SYMBOL	PARAMETER	TEST CONDITIONS	RATING	UNIT
$T_{stg}$	Storage Temperature Range		- 55 to +140	°C
$T_j$	Junction Temperature		- 55 to +140	°C
$V_{ESD}$	ESD Voltage Immunity	MIL-STD-883D, Method 3015.7, Human Body Model	± 2	kV <sub>peak</sub>
$I_{max\ LA-LB}$	Maximum Input Peak Current		± 60	mA <sub>peak</sub>

### NOTES:

- Stresses above those listed under Absolute Maximum Ratings may cause permanent damage to the device. This is a stress rating only and functional operation of the device at these or any conditions other than those described in the Operating Conditions and Electrical Characteristics section of this specification is not implied.
- This product includes circuitry specifically designed for the protection of its internal devices from the damaging effects of excessive static charge. Nonetheless, it is suggested that conventional precautions be taken to avoid applying greater than the rated maxima.

## OPERATING CONDITIONS

SYMBOL	PARAMETER	TEST CONDITIONS	MIN	TYP <sup>1</sup>	MAX	UNIT
$T_{amb}$	Operating Ambient Temperature		- 25		+ 70	°C
$T_{j\ op}$	Operating Junction Temperature		- 25		+ 85	°C
$I_{LA-LB}$	Input Current				30	mA <sub>rms</sub>
$V_{LA-LB\ rd}$	Minimum Supply Voltage <sup>2</sup> for READ/EAS	Standard Mode		± 3.1	± 3.7	V <sub>peak</sub>
$V_{LA-LB\ wr}$	Minimum Supply Voltage <sup>2</sup> for WRITE	Standard Mode		± 3.6	± 4.1	V <sub>peak</sub>
$V_{LA-LB\ fm}$	Minimum Supply Voltage <sup>2</sup> for READ/EAS/WRITE	Fast Mode		± 5.2	± 6.5	V <sub>peak</sub>
$f_{op}$	Operating Frequency <sup>3</sup>		13.553	13.560	13.567	MHz

### NOTES:

- Typical ratings are not guaranteed. These values listed are at room temperature.
- The voltage between LA and LB is limited by the on-chip voltage limitation circuitry (corresponding to parameter  $I_{LA-LB}$ ).
- Bandwidth limitation (±7 kHz) according to ISM band regulations.

## ELECTRICAL CHARACTERISTICS

$T_{amb} = - 25$  to  $+70$  °C

SYMBOL	PARAMETER	TEST CONDITIONS	MIN	TYP <sup>1</sup>	MAX	UNIT
$C_{res}$	Input Capacitance between LA - LB <sup>2</sup>	$V_{LA-LB} = 2\ V_{rms}$	22.3	23.5	24.7	pF
$P_{min}$	Minimum Operating Supply Power <sup>3</sup>	$V_{LA-LB} = 2\ V_{rms}$		200		μW
$m_{min}$	Minimum Modulation of RF Voltage for Demodulator Response	$m = \frac{V_{max} - V_{min}}{V_{max} + V_{min}}$		10	14	%
$m_{max}$	Maximum Modulation of RF Voltage for Demodulator Response	$m = \frac{V_{max} - V_{min}}{V_{max} + V_{min}}$	30			%
$t_{P\ sm}$	Modulation Pulse Length of RF Voltage <sup>4</sup>	Standard Mode, $m \geq 10\ %$	3.54	5.31 <sup>5</sup>	9.44	μs
$t_{P\ fm}$	Modulation Start-Pulse Length of RF Voltage <sup>4</sup>	Fast Mode, $m \geq 10\ %$	15.34	17.11 <sup>5</sup>	21.24	μs
$t_D$	Demodulator Response Time	$m \geq 10\ %$	0.1	0.8	2.4	μs
$R_{mod}$	Modulator ON Resistance	$I_{LA-LB} = 30\ mA$	50	115	250	Ω
$t_{ret}$	EEPROM Data Retention	$T_{amb} \leq 55\ °C$	10			Years
$n_{write}$	EEPROM Write Endurance		100 000			Cycles

### NOTES:

- Typical ratings are not guaranteed. These values listed are at room temperature.
- Measured with an HP4285A LCR meter at 13.56 MHz.
- Including losses in resonant capacitor and rectifier.
- The given values are derived from the 13.56 MHz system frequency.
- Recommended values for pulse duration generated at the read/write device.



---

## 14 Hints for Label IC Encapsulation

---

### 14.1 Protection against Visible Light

As a result of the ultra low power design of the I•CODE1 Label IC some analogue circuits on the chip are light sensitive. This means that common sun light can impact the operation of the label if the chip is not protected against visible light radiation.

Measurements have shown that a radiation of  $E_{\max} = 60 \text{ W/m}^2$  (spectrum: 400 to 1000 nm) causes a reduced operating range of the plain chip.

Measurements of direct sunlight in summer deliver values up to  $260 \text{ W/m}^2$ .

To ensure proper operation an expected minimum radiation reduction factor of approx. 9 ( $2 \times 260/60 = 8.7$ ) must be provided by the encapsulation. That means special care has to be taken to ensure a sufficient light protection of the I•CODE1 Label IC (e.g. non translucent encapsulation or underfiller, ...) according to application requirements.

### 14.2 Protection against UV Light

An EEPROM memory, as it is also used in the I•CODE1 Label IC, has some principle sensitivity to UV light (applies to EEPROM-technology in general).

Thus strong UV exposure in the production of inlets/labels has to be avoided. UV protection has to be ensured using appropriate assembly methods.

### 14.3 Resistance to X-Rays

X-ray exposure on comparable Philips ICs (with even smaller feature size) caused neither a long term influence on the behaviour of the ICs nor on the data retention of the EEPROMs.

---

# 15 Inlet/Label Characterisation and Test

---

## 15.1 Characterisation of the Inlet/Label

The parameters recommended to be characterised for the inlet/label are:

Parameter	Symbol	Conditions
Resonant frequency	$f_{res}$	Resonant frequency @ $T_{amb} = 22\text{ °C}$ @ $B_{TH}$ No command transmitted to the inlet/label → Label generates no response → No modulation
Threshold value for UNSELECTED READ command (standard mode)	$B_{TH}$	UNSELECTED READ command OK
Threshold value for WRITE command (standard mode)	$B_{WR}$	WRITE (and Verifying READ) command OK

## 15.2 Final Test of the Inlet/Label

Basic flow for production and test:

1. Production of wafer
2. Testing of dies on wafer
3. Writing of serial numbers and pre-configuration
4. Sawing of wafer
5. Assembly of inlets/labels
6. Final test of inlets/labels
7. Writing of customer data

**To detect damage of EEPROM cells during production of inlets/labels a final test of the EEPROM after assembly of the inlet/label is recommended. This is necessary to achieve lowest failure rates.**

# 16 Appendix A: Die Plan

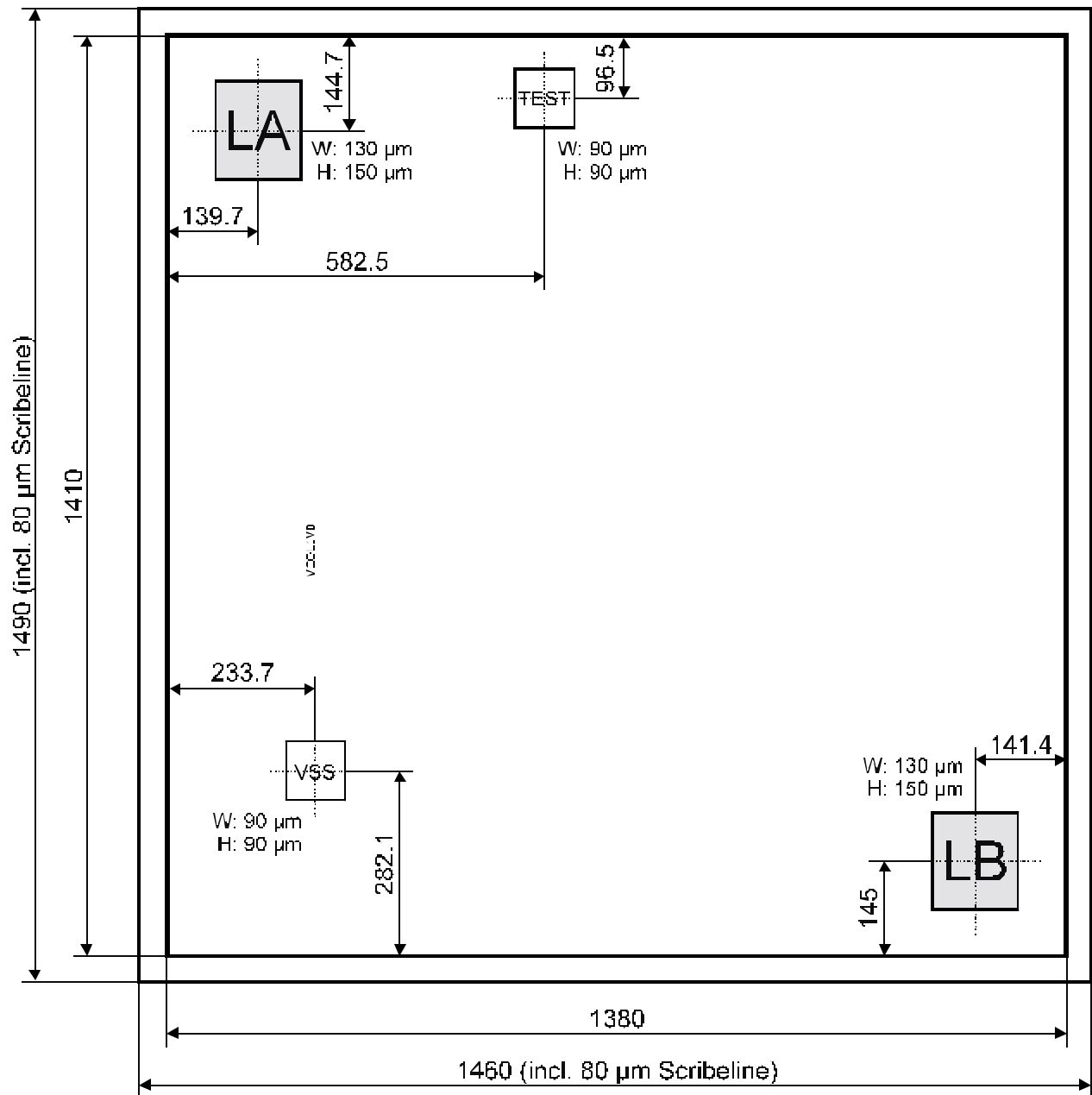

Measuring unit:  $\mu\text{m}$

**The two test pads (TEST and VSS) are electrically neutral at sawn wafers!**

# 17 Appendix B: Cluster Plan

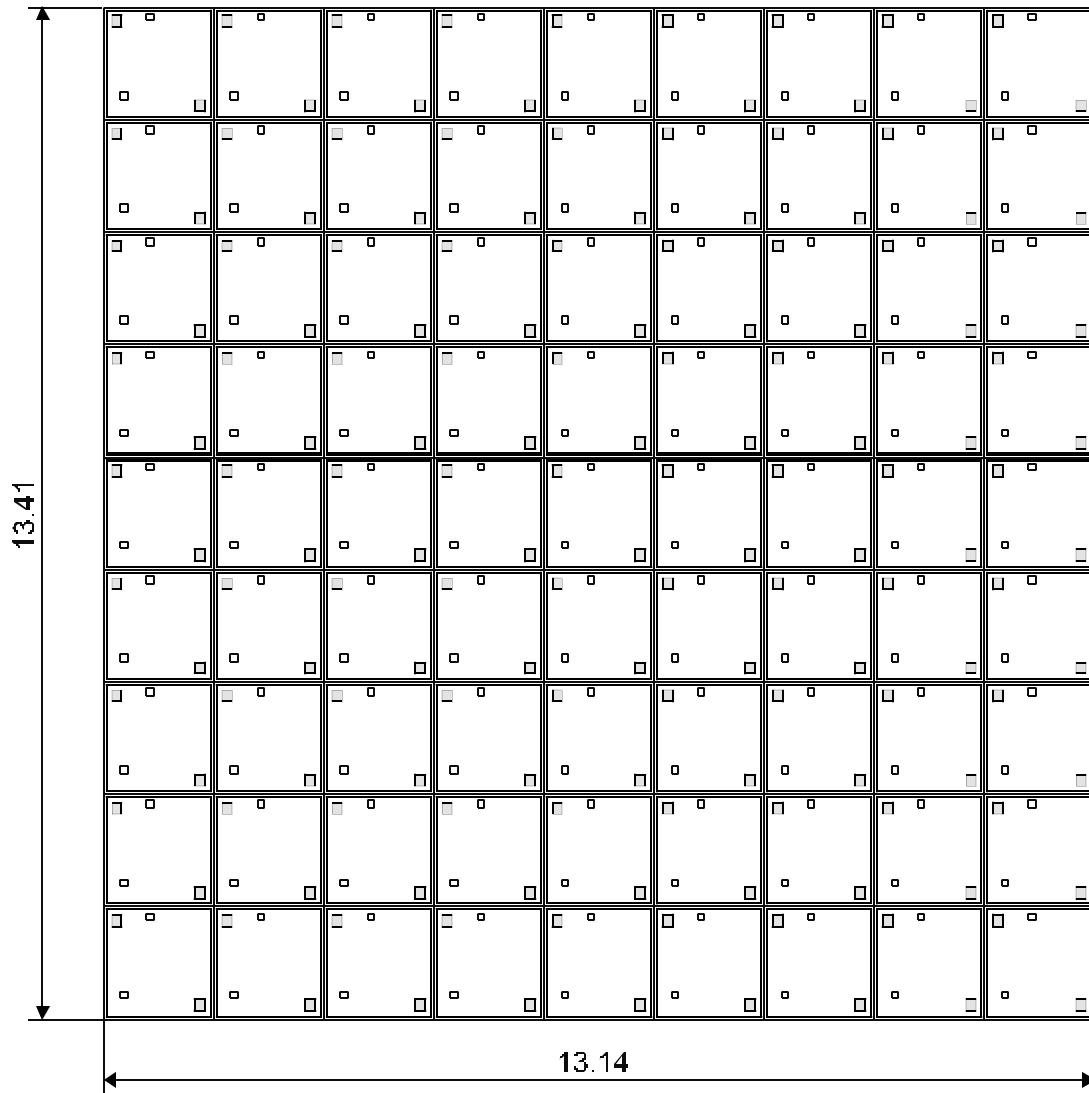

Measuring unit: mm

# 18 Appendix C: Cluster Map

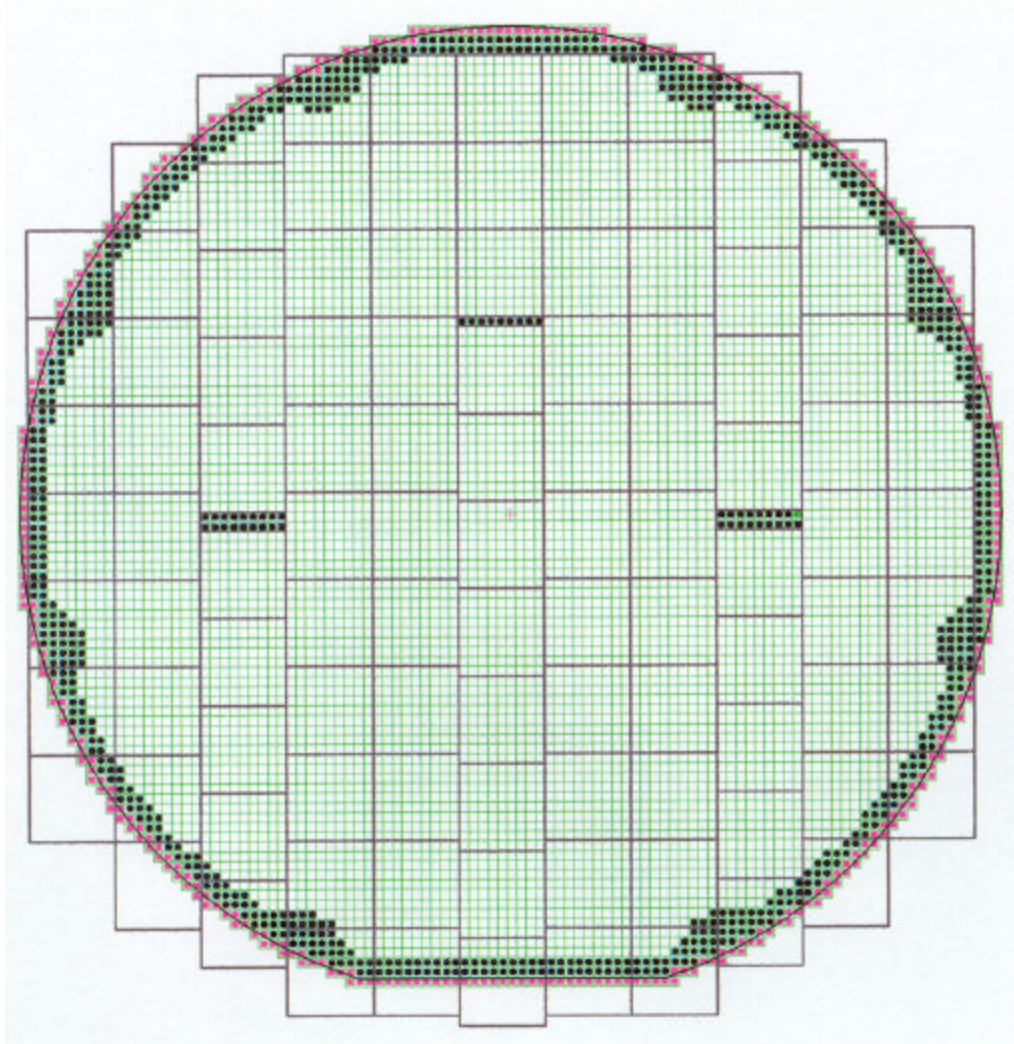

The three black lines show the position of the PCM structures on the 6 inch wafer!

# 19 REVISION HISTORY

**Table 1** Chip Specification SL1 ICS30 01 Revision History

<b>REVISION</b>	<b>DATE</b>	<b>CPCN</b>	<b>PAGE</b>	<b>DESCRIPTION</b>
2.1	Mai 2000			Previous version
2.2	Jan. 2005		5 9 11 12 14 15 21 22	Ordering Information update Note regarding EAS status added Mechanical Wafer Specification update Wafer Mapping format changed to IBIS Packing form update Handling Recommendation "Sawing" removed Appendix D removed Revision History added

# Philips Semiconductors - a worldwide company

**Argentina:** see South America

**Australia:** 34 Waterloo Road, North Ryde, NSW 2113,  
Tel. +61 2 9805-4455, Fax. +61 9 9805-4466

**Austria:** Computerstr. 6, A-1101 WIEN, P.O. Box 213,  
Tel. +43 1 60 101, Fax. +43 1 60 101 1210

**Belarus:** Hotel Minsk Business Center, Bld. 3, r. 1211, Volodarski  
Str. 6, 220050 MINSK, Tel. +375 172 200 733, Fax. +375 172 200 773

**Belgium:** see The Netherlands

**Brazil:** see South America

**Bulgaria:** Philips Bulgaria Ltd., Energoproject, 15th floor, 51 James  
Bourchier Blvd., 1407 SOFIA, Tel. +359 2 689 211, Fax. +359 2 689 102

**Canada:** see United States

**China/Hong Kong:** 501 Hong Kong Industrial Technology Centre, 72 Tat  
Chee Avenue, Kowloon Tong, Tel. +852 2811-9111, Fax. +852 2811-9173

**Colombia:** see South America

**Czech Republic:** see Austria

**Denmark:** Frederikskaj, Sydhavnsgade 23, DK-1780 Copenhagen V,  
Tel. +45 33 293333, Fax. +45 33 293905

**Finland:** Sinikalliontie 3, FIN-02630 ESPOO,  
Tel. +358 9 615800, Fax. +358 9 61580/xxx

**France:** 51, Rue Carnot - BP317 92156 Suresnes Cedex,  
Tel. +33 1 40 99 6161, Fax. +33 1 40 996427

**Germany:** Hammerbrookstrabe 69, D-20097 HAMBURG,  
Tel. +49 40 23 53 60, Fax. +49 40 23 536 300

**Greece:** No. 15, 25th March Street, GR 17778 TAVROS/ATHENS,  
Tel. +30 1 4894 339/239, Fax. +30 1 4814 240

**Hungary:** see Austria

**India:** Shivsagar Estate, Block 'A', Dr. Annie Besant Road, Worli,  
Mumbai-400 018, Tel. +91 22 492-1365, Fax. +91 22 493-8722

**Indonesia:** Gedung Philips, Jl. Buncit Raya Kav. 99-100,  
Jakarta 12510, Tel. +62 21 794-0040, Fax. +62 21 794-0080

**Ireland:** Newstead, Clonskeagh, DUBLIN 14,  
Tel. +353 1 7640 000, Fax. +353 1 7640 200

**Israel:** RAPAC Electronics, 7 Kehilat Saloniki St,  
TEL AVIV 61180, Tel. +972 3 645 0444, Fax. +972 3 648 1007

**Italy:** PHILIPS SEMICONDUCTORS, Piazza IV Novembre 3,  
20124 MILANO, Tel. +39 2 6752 2531, Fax. +39 2 6752 2557

**Japan:** Philips Bldg 13-37, Kohnan 2-chome, Minato-ku,  
Tokyo 108-8507, Tel. +81 3 3740-5130, Fax. +81 3 3740-5057

**Korea:** 260-199 Itaewon-dong, Yongsan-ku, Seoul, Korea C.,  
P.O. Box 3680, Tel. +82 2 709-1412, Fax. +82 2 709-1415

**Malaysia:** 76 Jalan Universiti, 46200 Petaling Jaya,  
Selangor, Tel. +60 3 757 5214, Fax. +60 3 757-4880

**Mexico:** Philips Components, El Paso, Texas, Tel. +1 915 772-4020

**Middle East:** see Italy

Published by:

**Philips Semiconductors Gratkorn GmbH, Mikron-Weg 1, A-8101 Gratkorn, Austria, Fax: +43 3124 299 270**

**For all other countries apply to:** Philips Semiconductors, International Marketing & Sales Communications,  
Building BE-p, P.O. Box 218, 5600 MD EINDHOVEN, The Netherlands, Fax: +31 40 27 24825  
**Internet:** <http://www.semiconductors.philips.com>

© Royal Philips Electronics N.V. 2000

All rights are reserved. Reproduction in whole or in part is prohibited without the prior written consent of the copyright owner.

The information presented in this document does not form part of any quotation or contract, is believed to be accurate and reliable and may be changed without notice. No liability will be accepted by the publisher for any consequence of its use. Publication thereof does not convey nor imply any license under patent- or other industrial or intellectual property rights.

**Netherlands:** Postbus 90050, 5600 PB EINDHOVEN, Bldg. VB,  
Tel. +31 40 27 82785, Fax. +31 40 27 88399

**New Zealand:** 2 Wagener Place, Mt Albert, C.P.O.Box 1041,  
Auckland, Tel. +64 9 815-4144, Fax. +64 9 849-7811

**Norway:** Box 1, Manglerud 0612, OSLO,  
Tel. +47 22 74 8000, Fax. +47 22 74 8341

**Pakistan:** see Singapore

**Philippines:** 106 Valero Street, Salcedo Village, Makati City,  
Metro Manila, Tel. +63 2 816-6380, Fax. +63 2 817-3474

**Poland:** Ul. Lukiska 10, PL 04-123 WARSZAWA,  
Tel. +48 22 612 2831, Fax. +48 22 612 2327

**Portugal:** see Spain

**Romania:** see Italy

**Russia:** Philips Russia, Ul. Usatcheva 35A, 119048 MOSCOW,  
Tel. +7 095 755 6918, Fax. +7 095 755 6919

**Singapore:** Lorong One, Toa Payoh, Singapore 319762,  
Tel. +65 350-2538, Fax. +65 251-6500/250-6010

**Slovakia:** see Austria

**Slovenia:** see Italy

**South Africa:** S.A. PHILIPS Pty Ltd., 195-215 Main Road  
Martindale, 2092 JOHANNESBURG, P.O. Box 7430 Johannesburg 2000,  
Tel. +27 11 470 5911, Fax. +27 11 470 5494

**South America:** Al. Vicente Pinzon, 173 - 6th floor,  
04547-130 Sao Paulo, SP - Brazil,  
Tel. +55 11 821 2333, Fax. +55 11 829 1849

**Spain:** Balmes 22, 08007 BARCELONA,  
Tel. +34 3 301 6312, Fax. +34 3 301 4107

**Sweden:** Kottbygatan 7, Akalla, S-16485 STOCKHOLM,  
Tel. +46 8 598 520 00, Fax. +46 8 632 2745

**Switzerland:** Allmendstrasse 140, CH-8027 ZÜRICH,  
Tel. +41 1 488 2686, Fax. +41 1 481 7730

**Taiwan R.O.C.:** 6th Floor, No. 96, Chien Kuo North Road, Sec.1,  
Taipei, Tel. +886 2 2134-2865, Fax. +886 2 2134-2874

**Thailand:** 209/2 Sanpavuth-Bangna Road, Prakanong, Bangkok 10260,  
Tel. +66 2 745-4090 x3261, Fax. +66 2 398-0793

**Turkey:** Talatpasa Cad. No. 5, 80640 GÜLTEPE/ISTANBUL,  
Tel. +90 212 279 2770, Fax. +90 212 282 6707

**Ukraine:** PHILIPS UKRAINE, 4 Patrice Lumumba str., Building B,  
Floor 7, 252042 KIEV, Tel. +380 44 264 2776, Fax. +380 44 268 0461

**United Kingdom:** Philips Semiconductors Ltd., 276 Bath Road, Hayes,  
MIDDLESEX UB3 5BX, Tel. +44 181 730 5000, Fax. +44 181 754 8421

**United States:** 811 East Arques Avenue, P.O. Box 3409, Sunnyvale,  
CA 94088-3409, Tel. +800 234 7381, Fax. +800 943 0087

**Uruguay:** see South America

**Vietnam:** see Singapore

**Yugoslavia:** PHILIPS, Trg N. Pasica 5/v, 11000 BEOGRAD,  
Tel. +381 11 625 344, Fax. +381 11 635 777



# PHILIPS

*Let's make things better.*